

Freescale Semiconductor

MPX10
Rev 14, 10/2008

10 kPa Uncompensated Silicon Pressure Sensors

The MPX10 series silicon piezoresistive pressure sensors provide a very accurate and linear voltage output, directly proportional to the applied pressure. These standard, low cost, uncompensated sensors permit manufacturers to design and add their own external temperature compensation and signal conditioning networks. Compensation techniques are simplified because of the predictability of Freescale's single element strain gauge design.

Features

- Low Cost
- Patented Silicon Shear Stress Strain Gauge Design
- Ratiometric to Supply Voltage
- Differential and Gauge Options
- Durable Epoxy Unibody Element or Thermoplastic (PPS) Surface Mount Package

MPX10 Series

0 to 10 kPa (0 to 1.45 psi)
35 mV Full Scale Span
(Typical)

Application Examples

- Air Movement Control
- Environmental Control Systems
- Level Indicators
- Leak Detection
- Medical Instrumentation
- Industrial Controls
- Pneumatic Control Systems
- Robotics

ORDERING INFORMATION

Device Name	Package Options	Case No.	# of Ports			Pressure Type			Device Marking
			None	Single	Dual	Gauge	Differential	Absolute	
Unibody Package (MPX10 Series)									
MPX10D	Tray	344	•				•		MPX10D
MPX10DP	Tray	344C			•		•		MPX10DP
MPX10GP	Tray	344B		•		•			MPX10GP
Small Outline Package (MPXV10G Series)									
MPXV10GC6U	Rail	482A		•		•			MPXV10G
MPXV10GC7U	Rail	482C		•		•			MPXV10G

SMALL OUTLINE PACKAGE

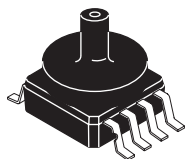

MPXV10GC6U
CASE 482A-01

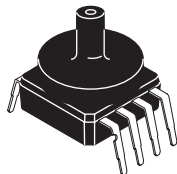

MPXV10GC7U
CASE 482C-03

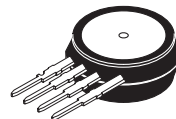

MPX10D
CASE 344-15

UNIBODY PACKAGE

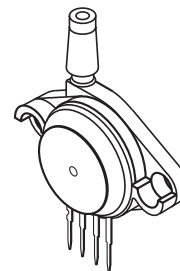

MPX10GP
CASE 344B-01

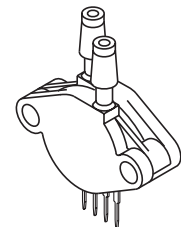

MPX10DP
CASE 344C-01

Operating Characteristics

Table 1. Operating Characteristics ($V_S = 3.0$ Vdc, $T_A = 25^\circ\text{C}$ unless otherwise noted, $P_1 > P_2$)

Characteristic	Symbol	Min	Typ	Max	Units
Differential Pressure Range ⁽¹⁾	P_{OP}	0	—	10	kPa
Supply Voltage ⁽²⁾	V_S	—	3.0	6.0	V _{DC}
Supply Current	I_O	—	6.0	—	mAdc
Full Scale Span ⁽³⁾	V_{FSS}	20	35	50	mV
Offset ⁽⁴⁾	V_{OFF}	0	20	35	mV
Sensitivity	$\Delta V/\Delta P$	—	3.5	—	mV/kPa
Linearity	—	-1.0	—	1.0	% V_{FSS}
Pressure Hysteresis (0 to 10 kPa)	—	—	±0.1	—	% V_{FSS}
Temperature Hysteresis	—	—	±0.5	—	% V_{FSS}
Temperature Coefficient of Full Scale Span	TCV_{FSS}	-0.22	—	-0.16	% $V_{FSS}/^\circ\text{C}$
Temperature Coefficient of Offset	TCV_{OFF}	—	±15	—	$\mu\text{V}/^\circ\text{C}$
Temperature Coefficient of Resistance	TCR	0.21	—	0.27	% $Z_{IN}/^\circ\text{C}$
Input Impedance	Z_{IN}	400	—	550	Ω
Output Impedance	Z_{OUT}	750	—	1250	Ω
Response Time ⁽⁵⁾ (10% to 90%)	t_R	—	1.0	—	ms
Warm-Up Time ⁽⁶⁾	—	—	20	—	ms
Offset Stability ⁽⁷⁾	—	—	±0.5	—	% V_{FSS}

- 1.0 kPa (kiloPascal) equals 0.145 psi.
- Device is ratiometric within this specified excitation range. Operating the device above the specified excitation range may induce additional error due to device self-heating.
- Full Scale Span (V_{FSS}) is defined as the algebraic difference between the output voltage at full rated pressure and the output voltage at the minimum rated pressure.
- Offset (V_{OFF}) is defined as the output voltage at the minimum rated pressure.
- Response Time is defined as the time for the incremental change in the output to go from 10% to 90% of its final value when subjected to a specified step change in pressure.
- Warm-up Time is defined as the time required for the product to meet the specified output voltage after the pressure is stabilized.
- Offset stability is the product's output deviation when subjected to 1000 hours of Pulsed Pressure, Temperature Cycling with Bias Test.

Maximum Ratings

Table 2. Maximum Ratings⁽¹⁾

Rating	Symbol	Value	Unit
Maximum Pressure (P1 > P2)	P_{MAX}	75	kPa
Burst Pressure (P1 > P2)	P_{BURST}	100	kPa
Storage Temperature	T_{STG}	-40 to +125	°C
Operating Temperature	T_A	-40 to +125	°C

1. Exposure beyond the specified limits may cause permanent damage or degradation to the device.

Figure 1 shows a schematic of the internal circuitry on the stand-alone pressure sensor chip.

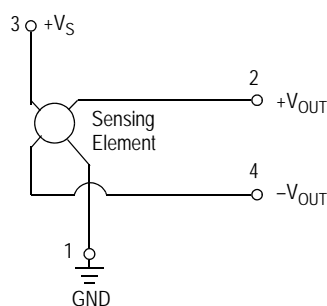

Figure 1. Uncompensated Pressure Sensor Schematic

Voltage Output versus Applied Differential Pressure

The output voltage of the differential or gauge sensor increases with increasing pressure applied to the pressure side (P1) relative to the vacuum side (P2). Similarly, output

voltage increases as increasing vacuum is applied to the vacuum side (P2) relative to the pressure side (P1).

Temperature Compensation

Figure 2 shows the typical output characteristics of the MPX10 series over temperature.

Because this strain gauge is an integral part of the silicon diaphragm, there are no temperature effects due to differences in the thermal expansion of the strain gauge and the diaphragm, as are often encountered in bonded strain gauge pressure sensors. However, the properties of the strain gauge itself are temperature dependent, requiring that the device be temperature compensated if it is to be used over an extensive temperature range.

Temperature compensation and offset calibration can be achieved rather simply with additional resistive components, or by designing your system using the MPX2010D series sensor.

LINEARITY

Linearity refers to how well a transducer's output follows the equation: $V_{out} = V_{off} + \text{sensitivity} \times P$ over the operating pressure range (Figure 3). There are two basic methods for calculating nonlinearity: 1) end point straight line fit or 2) a least squares best line fit. While a least squares fit gives the

"best case" linearity error (lower numerical value), the calculations required are burdensome.

Conversely, an end point fit will give the "worst case" error (often more desirable in error budget calculations) and the calculations are more straightforward for the user. Freescale's specified pressure sensor linearities are based on the end point straight line method measured at the midrange pressure.

Figure 4 illustrates the differential or gauge configuration in the basic chip carrier (Case 344). A silicone gel isolates the die surface and wire bonds from the environment, while allowing the pressure signal to be transmitted to the silicon diaphragm.

The MPX10 series pressure sensor operating characteristics and internal reliability and qualification tests are based on use of dry air as the pressure media. Media other than dry air may have adverse effects on sensor performance and long term reliability. Contact the factory for information regarding media compatibility in your application. Refer to application note AN3728, for more information regarding media compatibility.

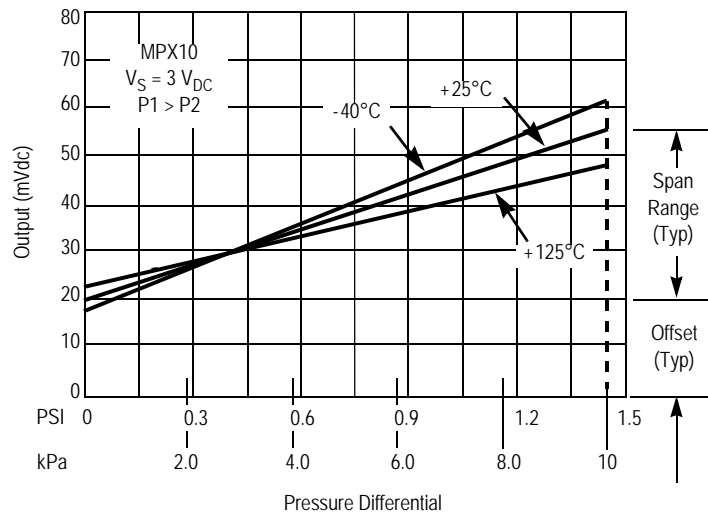

Figure 2. Output vs. Pressure Differential

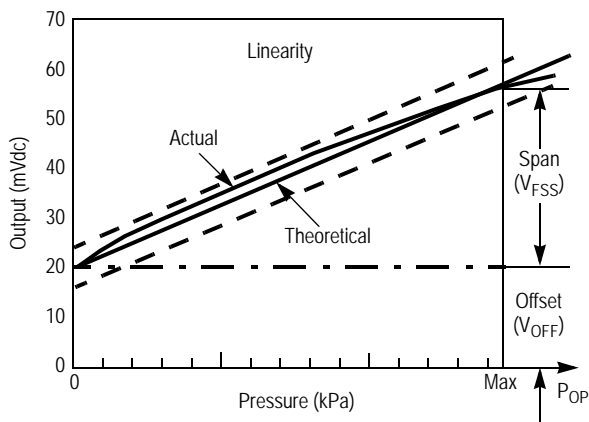

Figure 3. Linearity Specification Comparison

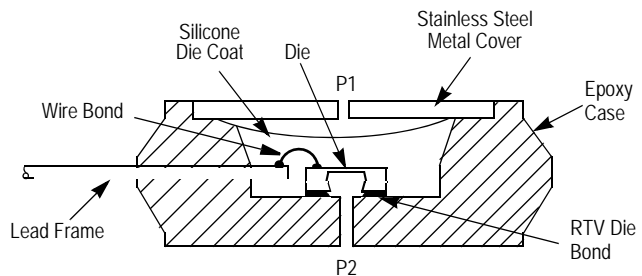

Figure 4. Unibody Package — Cross-Sectional Diagram (Not to Scale)

PRESSURE (P1)/VACUUM (P2) SIDE IDENTIFICATION TABLE

Freescale designates the two sides of the pressure sensor as the Pressure (P1) side and the Vacuum (P2) side. The Pressure (P1) side is the side containing silicone gel which isolates the die from the environment. The pressure sensor is designed to operate with positive differential pressure applied, $P1 > P2$.

The Pressure (P1) side may be identified by using the following table.

Part Number	Case Type	Pressure (P1) Side Identifier
MPX10D	344	Stainless Steel Cap
MPX10DP	344C	Side with Part Marking
MPX10GP	344B	Side with Port Attached
MPXV10GC6U	482A	Side with Port Attached
MPXV10GC7U	482C	Side with Port Attached

PACKAGE DIMENSIONS

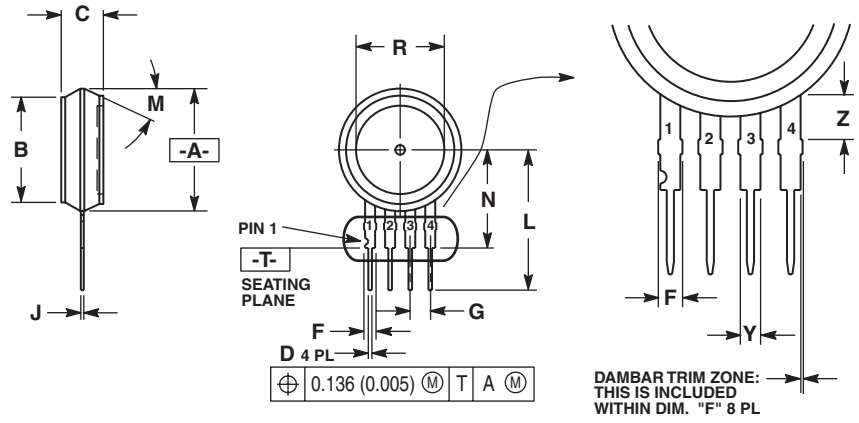

- NOTES:
1. DIMENSIONING AND TOLERANCING PER ASME Y14.5M, 1994.
 2. CONTROLLING DIMENSION: INCH.
 3. DIMENSION -A- IS INCLUSIVE OF THE MOLD STOP RING. MOLD STOP RING NOT TO EXCEED 16.00 (0.630).

**CASE 344-15
ISSUE AA
UNIBODY PACKAGE**

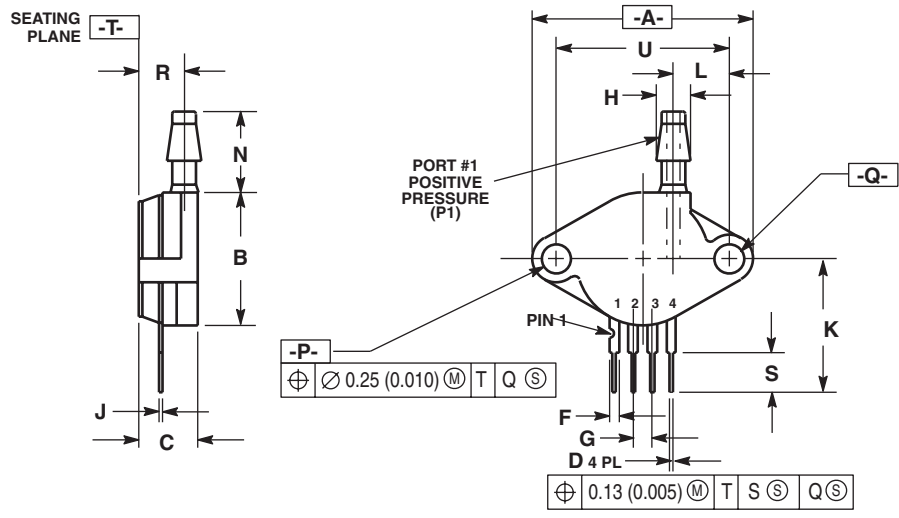

- NOTES:
1. DIMENSIONING AND TOLERANCING PER ANSI Y14.5M, 1982.
 2. CONTROLLING DIMENSION: INCH.

**CASE 344B-01
ISSUE B
UNIBODY PACKAGE**

PACKAGE DIMENSIONS

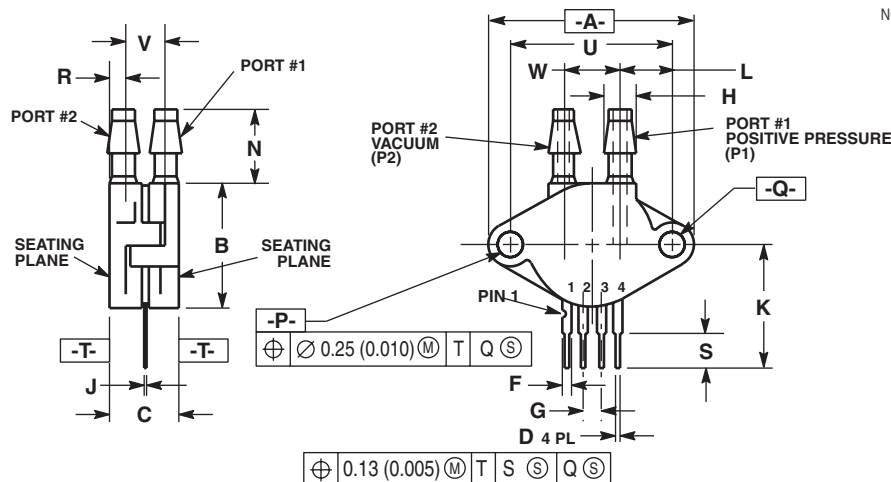

- NOTES:
1. DIMENSIONING AND TOLERANCING PER ANSI Y14.5M, 1982.
 2. CONTROLLING DIMENSION: INCH.

DIM	INCHES		MILLIMETERS	
	MIN	MAX	MIN	MAX
A	1.145	1.175	29.08	29.85
B	0.685	0.715	17.40	18.16
C	0.405	0.435	10.29	11.05
D	0.016	0.020	0.41	0.51
F	0.048	0.064	1.22	1.63
G	0.100 BSC		2.54 BSC	
H	0.182	0.194	4.62	4.93
J	0.014	0.016	0.36	0.41
K	0.695	0.725	17.65	18.42
L	0.290	0.300	7.37	7.62
N	0.420	0.440	10.67	11.18
P	0.153	0.159	3.89	4.04
Q	0.153	0.159	3.89	4.04
R	0.063	0.083	1.60	2.11
S	0.220	0.240	5.59	6.10
U	0.910 BSC		23.11 BSC	
V	0.248	0.278	6.30	7.06
W	0.310	0.330	7.87	8.38

**CASE 344C-01
ISSUE B
UNIBODY PACKAGE**

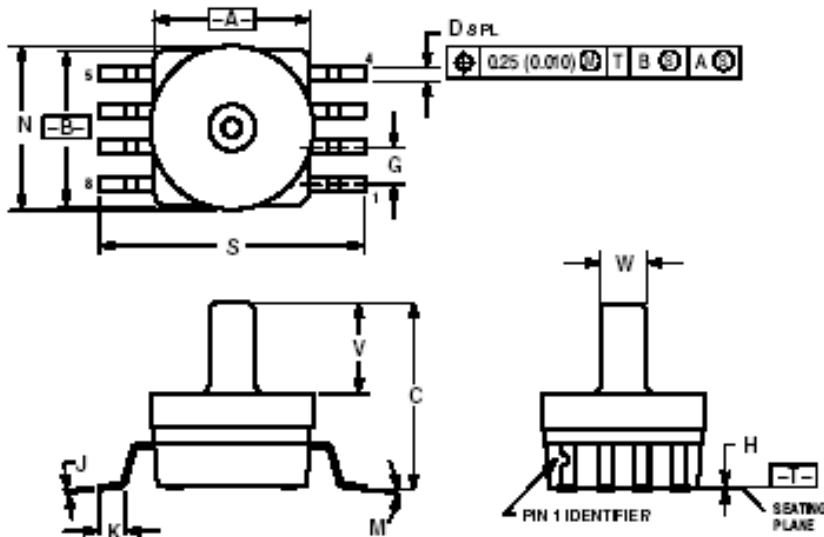

- NOTES:
1. DIMENSIONING AND TOLERANCING PER ANSI Y14.5M, 1982.
 2. CONTROLLING DIMENSION: INCH.
 3. DIMENSION A AND B DO NOT INCLUDE MOLD PROTRUSION.
 4. MAXIMUM MOLD PROTRUSION 0.015 (0.006).
 5. ALL VERTICAL SURFACES 5° TYPICAL DRAFT.

DIM	INCHES		MILLIMETERS	
	MIN	MAX	MIN	MAX
A	0.415	0.425	10.54	10.79
B	0.415	0.425	10.54	10.79
C	0.500	0.520	12.70	13.21
D	0.036	0.042	0.91	1.07
G	0.100 BSC		2.54 BSC	
H	0.000	0.010	0.00	0.25
J	0.009	0.011	0.23	0.28
K	0.061	0.071	1.55	1.80
M	0°	7°	0°	7°
N	0.444	0.448	11.26	11.38
S	0.702	0.725	18.01	18.41
V	0.245	0.255	6.22	6.48
W	0.115	0.125	2.90	3.17

**CASE 482A-01
ISSUE A
SMALL OUTLINE PACKAGE**

PACKAGE DIMENSIONS

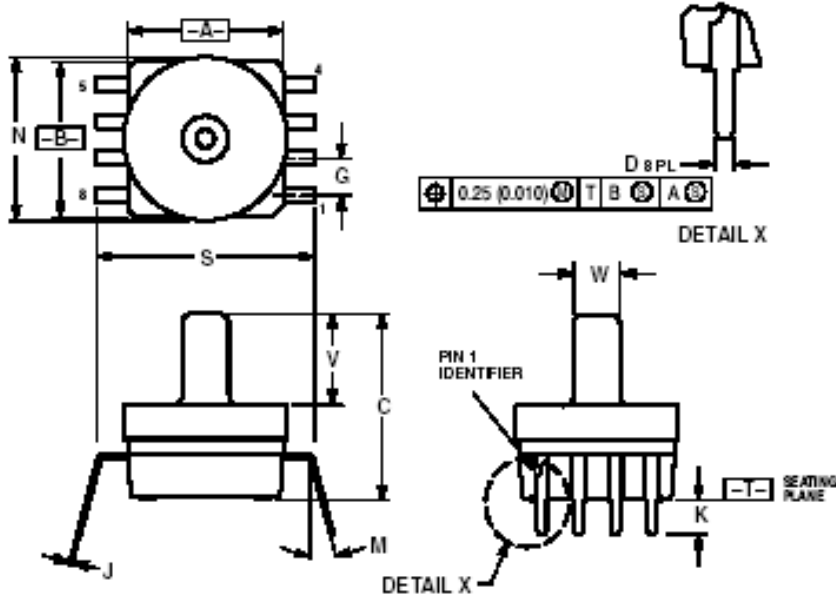

- NOTES:
1. DIMENSIONING AND TOLERANCING PER ANSI Y14.5M, 1982.
 2. CONTROLLING DIMENSION: INCH.
 3. DIMENSION A AND B DO NOT INCLUDE MOLD PROTRUSION.
 4. MAXIMUM MOLD PROTRUSION 0.15 (0.006).
 5. ALL VERTICAL SURFACES 5° TYPICAL DRAFT.
 6. DIMENSIONS TO CENTER OF LEAD WHEN FORMED PARALLEL.

DIM	INCHES		MILLIMETERS	
	MIN	MAX	MIN	MAX
A	0.415	0.425	10.54	10.79
B	0.415	0.425	10.54	10.79
C	0.500	0.520	12.70	13.21
D	0.028	0.034	0.66	0.864
G	0.100 BSC		2.54 BSC	
J	0.009	0.011	0.23	0.28
K	0.100	0.120	2.54	3.05
M	0°	15°	0°	15°
N	0.444	0.448	11.28	11.38
S	0.540	0.580	13.72	14.72
V	0.245	0.255	6.22	6.48
W	0.115	0.125	2.92	3.17

CASE 482C-03
ISSUE B
SMALL OUTLINE PACKAGE

How to Reach Us:

Home Page:

www.freescale.com

Web Support:

<http://www.freescale.com/support>

USA/Europe or Locations Not Listed:

Freescale Semiconductor, Inc.
Technical Information Center, EL516
2100 East Elliot Road
Tempe, Arizona 85284
1-800-521-6274 or +1-480-768-2130
www.freescale.com/support

Europe, Middle East, and Africa:

Freescale Halbleiter Deutschland GmbH
Technical Information Center
Schatzbogen 7
81829 Muenchen, Germany
+44 1296 380 456 (English)
+46 8 52200080 (English)
+49 89 92103 559 (German)
+33 1 69 35 48 48 (French)
www.freescale.com/support

Japan:

Freescale Semiconductor Japan Ltd.
Headquarters
ARCO Tower 15F
1-8-1, Shimo-Meguro, Meguro-ku,
Tokyo 153-0064
Japan
0120 191014 or +81 3 5437 9125
support.japan@freescale.com

Asia/Pacific:

Freescale Semiconductor China Ltd.
Exchange Building 23F
No. 118 Jianguo Road
Chaoyang District
Beijing 100022
China
+86 010 5879 8000
support.asia@freescale.com

For Literature Requests Only:

Freescale Semiconductor Literature Distribution Center
P.O. Box 5405
Denver, Colorado 80217
1-800-441-2447 or +1-303-675-2140
Fax: +1-303-675-2150
LDCForFreescaleSemiconductor@hibbertgroup.com

Information in this document is provided solely to enable system and software implementers to use Freescale Semiconductor products. There are no express or implied copyright licenses granted hereunder to design or fabricate any integrated circuits or integrated circuits based on the information in this document.

Freescale Semiconductor reserves the right to make changes without further notice to any products herein. Freescale Semiconductor makes no warranty, representation or guarantee regarding the suitability of its products for any particular purpose, nor does Freescale Semiconductor assume any liability arising out of the application or use of any product or circuit, and specifically disclaims any and all liability, including without limitation consequential or incidental damages. "Typical" parameters that may be provided in Freescale Semiconductor data sheets and/or specifications can and do vary in different applications and actual performance may vary over time. All operating parameters, including "Typicals", must be validated for each customer application by customer's technical experts. Freescale Semiconductor does not convey any license under its patent rights nor the rights of others. Freescale Semiconductor products are not designed, intended, or authorized for use as components in systems intended for surgical implant into the body, or other applications intended to support or sustain life, or for any other application in which the failure of the Freescale Semiconductor product could create a situation where personal injury or death may occur. Should Buyer purchase or use Freescale Semiconductor products for any such unintended or unauthorized application, Buyer shall indemnify and hold Freescale Semiconductor and its officers, employees, subsidiaries, affiliates, and distributors harmless against all claims, costs, damages, and expenses, and reasonable attorney fees arising out of, directly or indirectly, any claim of personal injury or death associated with such unintended or unauthorized use, even if such claim alleges that Freescale Semiconductor was negligent regarding the design or manufacture of the part.

Freescale™ and the Freescale logo are trademarks of Freescale Semiconductor, Inc. All other product or service names are the property of their respective owners.

© Freescale Semiconductor, Inc. 2008. All rights reserved.